

INTRODUCTION

This document contains information about configuring RHT relative humidity transmitter with a touchscreen user interface. Before reading this guide, check that the transmitter has been installed according to the installation instructions.

This document describes the menu structures of the transmitter and all the settings that can be adjusted in the menus. Plenty of screen shots and descriptions make the use of the transmitter simple and easy just by following this guide.

NAVIGATING THE MENU

Press and hold the screen for three seconds to enter the setup menu.

Note that if the locking jumper has been installed, nothing will happen on the display. See more instructions about the locking jumper in the installation instructions.



There are four ways to navigate the menu structures:



Go back to previous menu without changes



Accept changes and return to the previous menu



Slide your finger up/down to navigate between the modes



Slide your finger left/right to navigate between the parameters

STEP 1: MEASURING MODES

There are five different presentations that can be set for the screen display (see Figure 1). All values can be displayed individually or with different combinations or with trend diagrams. One can choose all or just a few measuring modes and display them sequentially on the screen.

Figure 1 - Measuring modes

Example

One reading

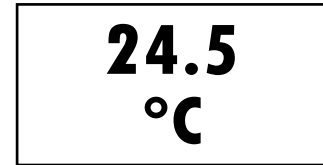
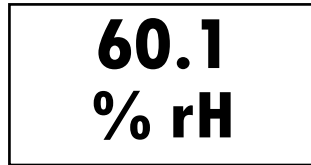

Two readings
at the same time

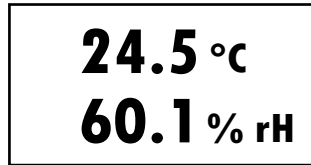

Trend diagram

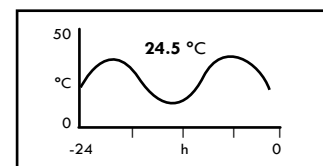
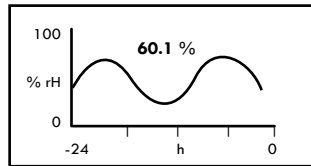

STEP 2: DISPLAY MODE

Press and hold the screen for three seconds to enter the setup menu.



The setup menu will appear on the screen (see Figure 2). Note that if the locking jumper has been installed, nothing will happen on the display. See more instructions about the locking jumper in the installation instructions.

Figure 2

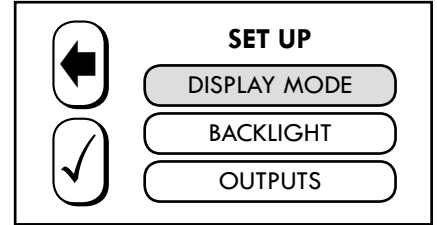

Press DISPLAY MODE. INFO view opens instructing how to navigate between the modes. Press the screen to close the INFO view right away. READING view will appear on the screen. Slide your finger left/right or up/down to navigate between the views (see Figure 3). Select the desired view and press accept button to accept the view.

Figure 3 - Display mode

One reading

←
1 READING
60.1
% rH

← →

←
1 READING
24.5
°C

Two readings at the same time

←
2 READINGS
24.5 °C
60.1 % rH

Trend diagram

←
% RH GRAPH

← →

←
TEMP. GRAPH

Auto-change mode

←
CYCLE DISPLAY
MODE (✓) EVERY
 ← **4 s** →
 ← → = Set interval

Select interval to automatically change display

←
CYCLE DISPLAY
MODE (✓) EVERY
 ← **4 s** →
 ← → = Set interval

STEP 2: DISPLAY MODE CONTINUED

If you want different views to be displayed sequentially, check the box on the top-right corner of the view to add it (see Figure 4).

Figure 4

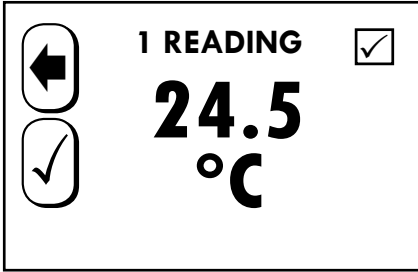

Check/uncheck upper-right box to include or exclude.

- = Included in the Auto-change Mode.
- = Excluded from the Auto-change Mode.

Note: Functions ONLY when Auto-change Mode is the selected Display Mode.

The auto-change mode (Figure 5) has to be selected in Display Mode menu to activate the sequential view. To activate auto-change mode, adjust the time between views, then press , accept button, to make changes or go back to the previous menu without changes by pressing .

Figure 5

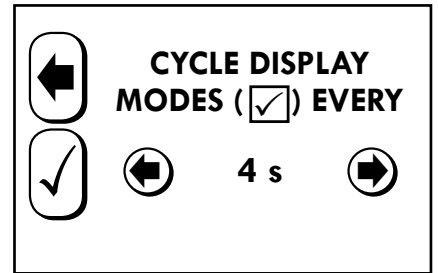

STEP 3: BACKLIGHT LEVEL

Figure 6

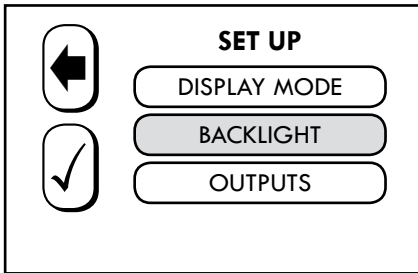

In the SET UP menu choose BACKLIGHT. Slide your finger left/right and select the suitable backlight brightness. Press to accept the changes or go back to the previous menu without changes by pressing .

Figure 6b

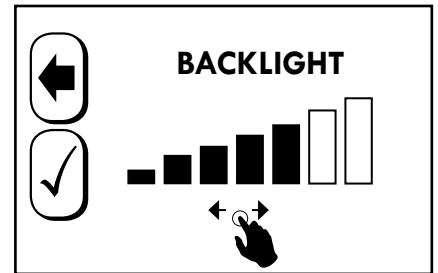

STEP 4: OUTPUTS

Figure 7

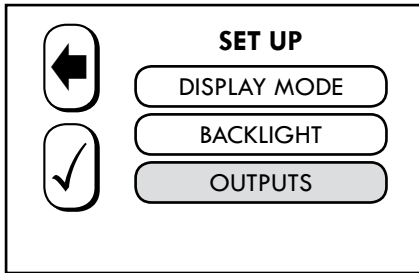

In the SET UP menu choose OUTPUTS. Select P-BANDS to adjust the measurement ranges. Select OUTPUT MODES to choose between different output options. Select RELAY to configure a relay output. Selection is only available if a relay is installed.

Figure 7b

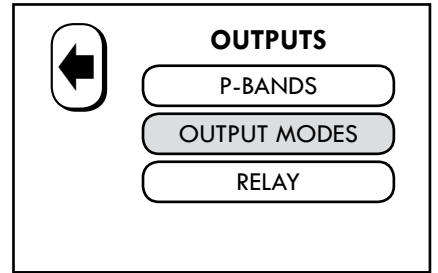

OFFSET

- 1) In the SET UP menu choose OUTPUTS
- 2) Select P-BANDS
- 3) Select desired parameter and choose OFFSET

3.1) Adjust humidity offset: $\pm 10\%$ rH, Offset feature enables field calibration. This is necessary in demanding applications requiring annual calibration.

Figure 8

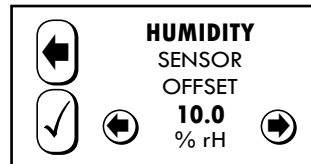

3.2) Adjust temperature offset: $\pm 5\text{ }^\circ\text{C}$ or $\pm 9\text{ }^\circ\text{F}$

Figure 8b

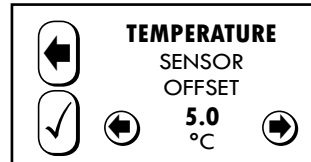

- 4) Press to accept changes or press to return to the previous menu without making changes.

OFFSET (MODBUS)

- 1) In the SET UP menu choose OUTPUTS
- 2) Select REGULATOR
- 3) Select P-BANDS
- 4) Select OFFSET
- 5) Select desired parameter and adjust the parameter (see figure 8)
- 6) Press to accept changes or press to return to the previous menu without making changes.

STEP 5: P-BANDS

Press the desired parameter to adjust the output range. Pressing the screen will close the INFO view right away. If the screen is not pressed the INFO view will close after a few seconds.

Press HIGH LIMIT or LOW LIMIT to set the limits for the output (See Picture 9). Press to accept changes or press to return to the previous menu without making changes. To change selection between current and voltage outputs see the installation instructions.

Figure 9b

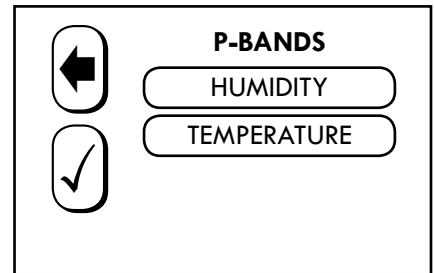
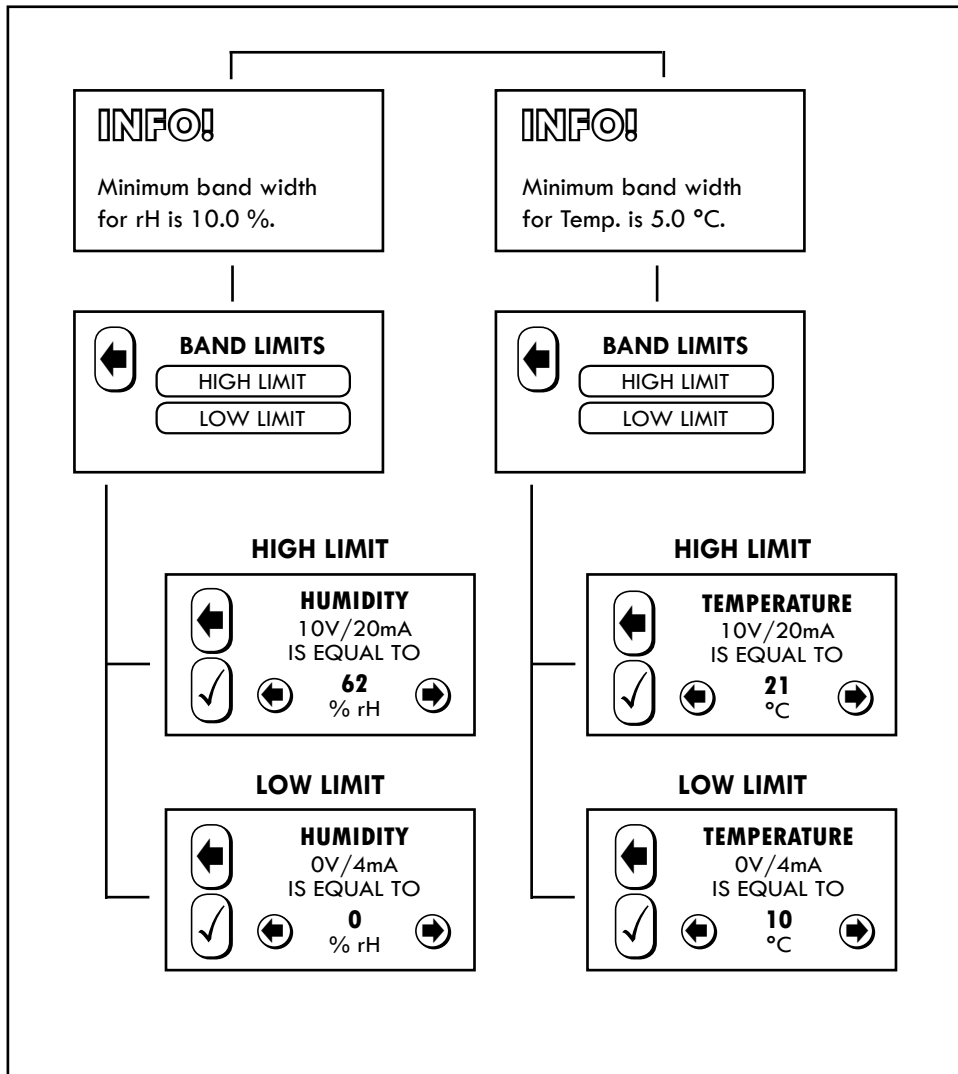

Figure 9 - P-Bands



STEP 6: OUTPUT MODES

Select MAX VALUE OUT to enable comparison between rH and temperature values. The one that is higher will be output from the NC terminal (See Figure 9).

Select 0/2-10 V to choose between 0-10 V voltage output and 2-10 V voltage output.

Figure 10

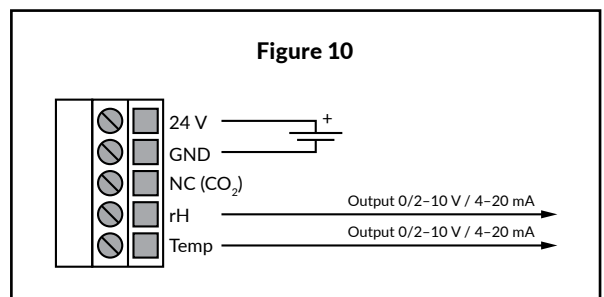

STEP 7: OPTIONAL RELAY

Figure 11

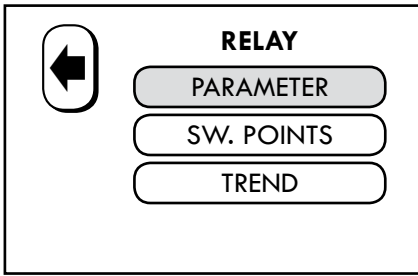

Menu is only available if a relay is installed. Press PARAMETER to select the desired parameter.

Select the desired PARAMETER and press to accept the changes or return to the previous menu without changes by pressing .

Figure 12

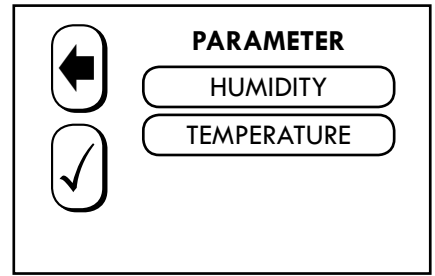

Press SW. POINTS to set the relay's switching points. Set RELAY ON and RELAY OFF points and press to accept changes or return to the previous menu without changes by pressing .

Figure 13

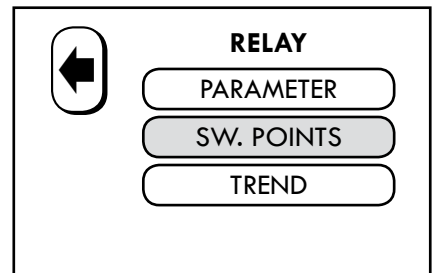

Figure 14 - SW. points

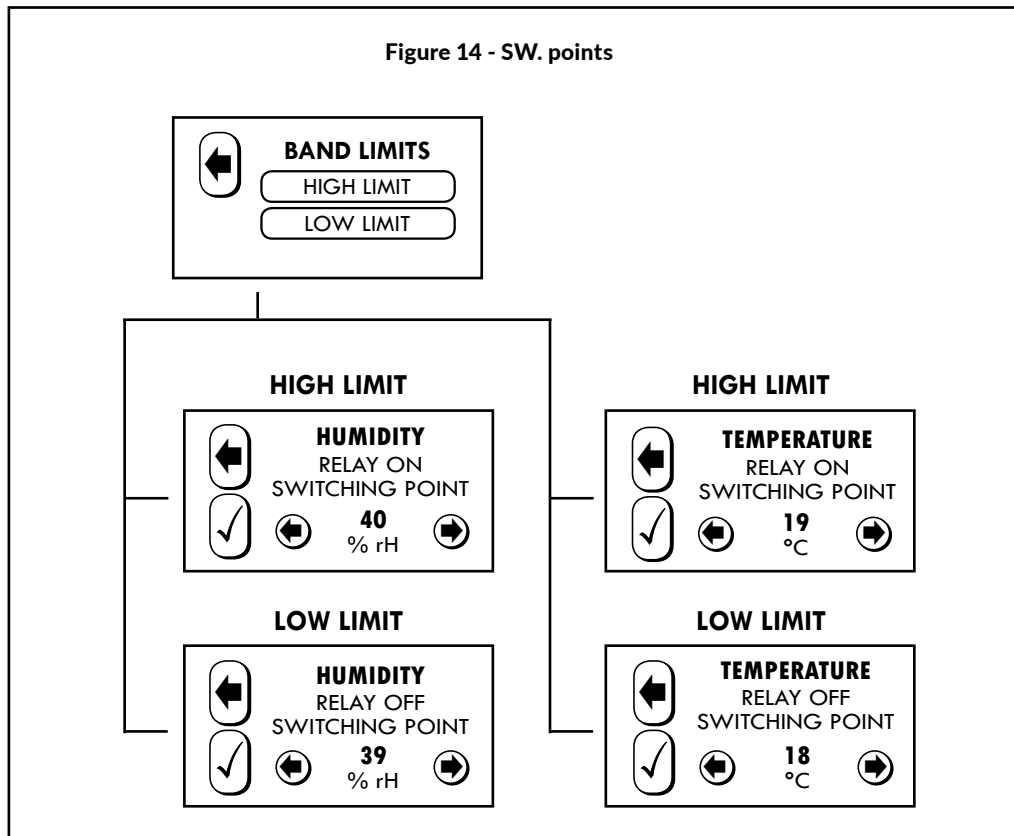
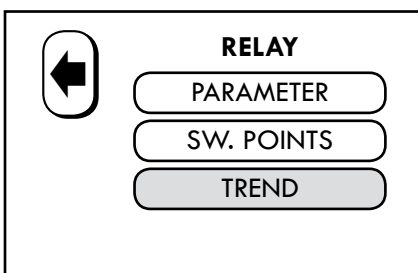

Figure 15



Press TREND to set the switching trend of the relay.

Select INCREASING or DECREASING and press to accept changes or return to the previous menu without changes by pressing .

Figure 16

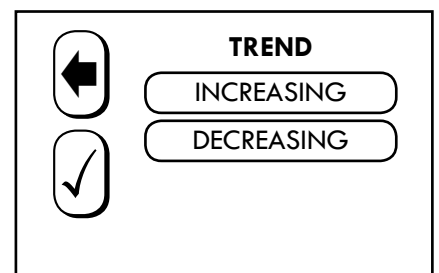

STEP 8: OPTIONAL MODBUS

Figure 17

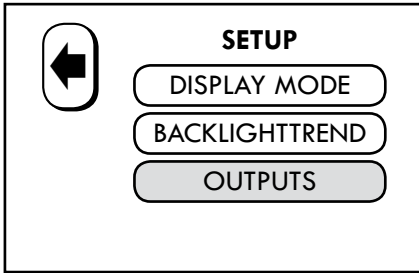

Menu is only available if MODBUS is supported.

Press OUTPUTS.

Press MODBUS.

Figure 18

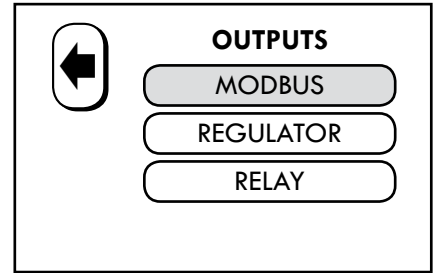

Set ADDRESS, BAUD RATE and PARITY BIT and press to accept changes or return to the previous menu without changes by pressing .

Figure 19 - Modbus

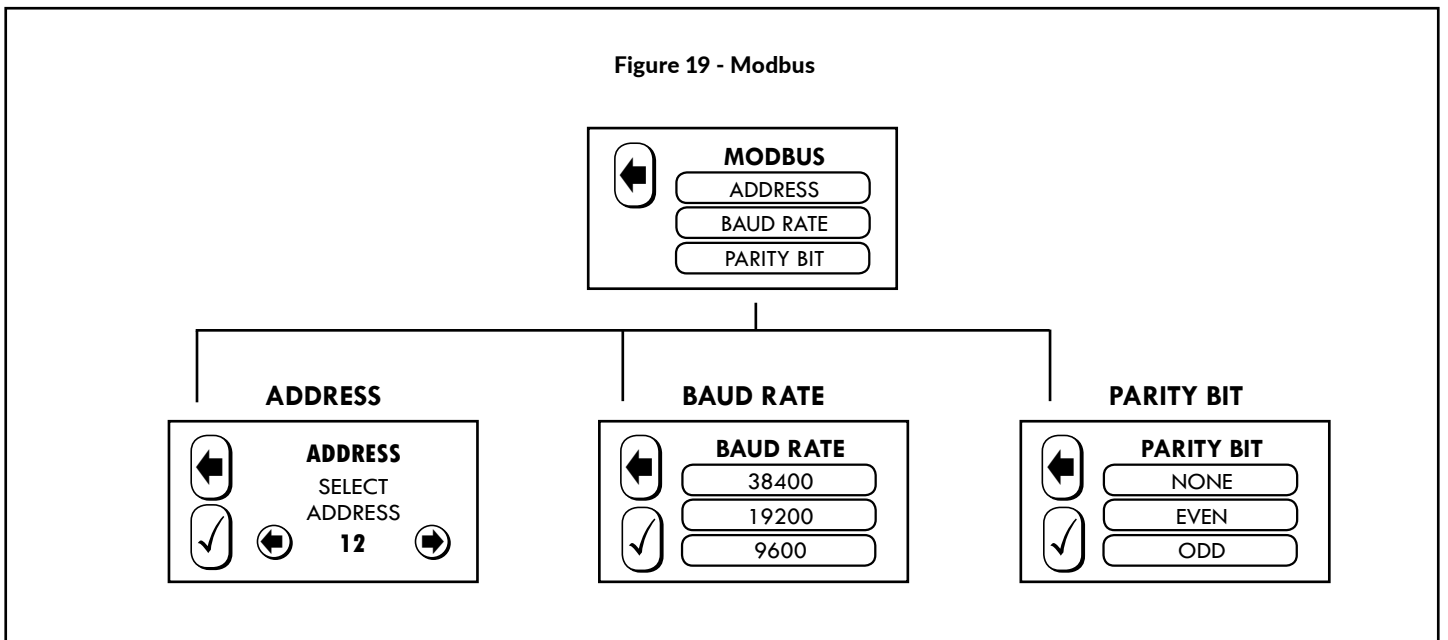

Press REGULATOR to set the PARAMETER and P-BAND values.

Select the desired PARAMETER and press to accept changes or return to the previous menu without changes by pressing . Press P-BAND to set LOW and HIGH limits.

Figure 20

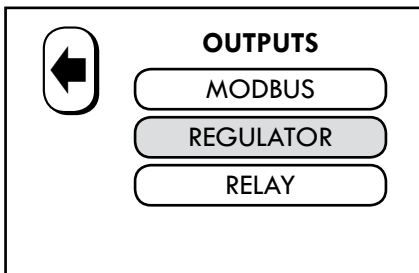

Figure 21

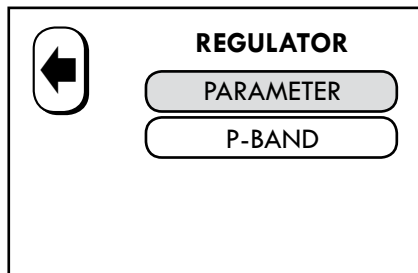
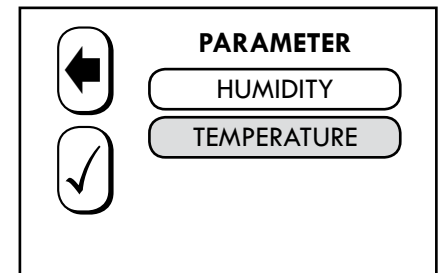

Figure 22



See Figure 9 for setting the P-Band.